

SWAN 1000

PASSIVE INFRARED & MICROWAVE DETECTOR With PET IMMUNITY

PRODUCT FEATURES

A new generation of professional movement spread spectrum analyzing PIR & MW detectors with PET immune function.

The Swan 1000 is a combination of PIR & MW detectors, providing protection from intruders by PYRO sensor element and MW (based on Doppler concept). Using micro controller for PIR & MW signal analyzing, with special ASIC technology for PIR pulse processing, assures "false alarm free" operation.

- Quad (Four element) PYRO sensor and hard lens for outstanding detection performance and elimination of false alarms.
- Microwave detection based on Doppler concept.
- Unique Microwave Motion Sensor Module with microstrip patch antenna.
- VLSI based electronics with movement speed spectrum analysis.
- Height installation calibrations free.
- User-friendly installation with or w/o swivel bracket.
- 2-way Microwave sensitivity adjustment.
- 2-way PIR sensitivity adjustment.
- Bi directional temperature compensation.
- Environmental immunity.
- The Swan 1000 provides *pet immunity* up to 25Kg. Pet active bellow 1m.

SELECT MOUNTING LOCATION

Choose a location most likely to intercept an intruder. (Our recommendation is a corner installation). See detection pattern – fig.4. The quad-element high quality sensor detects motion crossing the beam; it is slightly less sensitive detecting motion toward the detector.
Recommended mounting height – 1.8m-2.4m.

AVOID THE FOLLOWING LOCATIONS

- Facing direct sunlight.
- Facing areas that may change temperature rapidly.
- Areas where there are air ducts or substantial airflows.
- Areas where the field of view of the detector is obstructed with furniture or other objects

The Swan 1000 performs better when provided with a constant and stable environment.

NOTE:

Walk tests should be conducted after installation and at least once a year, to confirm proper operation and coverage of the protected area.

DETECTOR INSTALLATION

The detector can either be wall or corner mounted. If ceiling or special wall mounting is required, use the optional bracket base. Refer to bracket description. (See fig. 7).

1. To remove the front cover, unscrew the holding screw and gently raise the front cover.

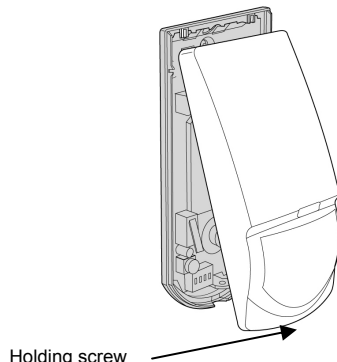
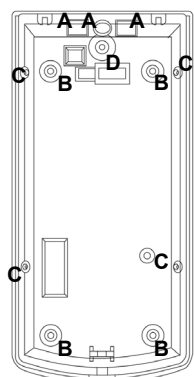

Fig.1

2. To remove the PC board, carefully unscrew the holding screw located on the PC board.
3. Break out the desired holes for proper installation.



- A. Wire access holes
- B. Use for flat wall mounting
- C. Corner mounting - use all 4 holes. Sharp left or right angle mounting - use 2 holes (top and bottom)
- D. For bracket mounting

Fig. 2

4. The circular and rectangular indentations at the bottom base are the knockout holes for wire entry. You may also use mounting holes that are not in use for running the wiring into the detector. (For option with bracket - lead wire through the bracket – fig.7)
5. Mount the detector base to the wall, corner or ceiling. (For option with bracket see fig.7).
6. Reinstall the PC board by fully tightening the holding screw. Connect wire to terminal block.
7. Replace the cover by inserting it back in the appropriate closing pins and screw in the holding screw.

DETECTOR CONNECTION

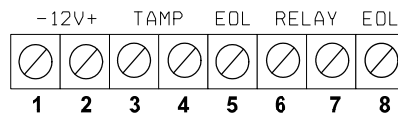

Terminal 1 - Marked " - " (GND)
Connect to the negative Voltage or ground of the control panel.

Terminal 2 - Marked " + " (+12V)
Connect to a positive Voltage of 9.6 -16Vdc source (usually from the alarm control unit)

Terminals 3 & 4 - Marked " TAMP "
If a Tamper function is required connect these terminals to a 24-hour normally closed protective zone in the control unit. If the front cover of the detector is opened, an immediate alarm signal will be sent to the control unit.

Terminals 5 & 8 - Marked " EOL " – End of line option.

Terminals 6 & 7 - Marked " RELAY "
These are the output relay contacts of the detector. Connect to a normally closed zone in the control panel.

TESTING THE DETECTOR

Wait for one minute warm up time after applying 12 Vdc power. Conduct testing with the protected area cleared of all people.

Walk test

1. Remove front cover. Set LED to ON position.
2. Reassemble the front cover.
3. Start walking slowly across the detection zone.
4. Observe that the red LED lights whenever motion is detected.
5. Allow 5 sec. between each test for the detector to stabilize.
6. After the walk test is completed, you can set the LED to OFF position.

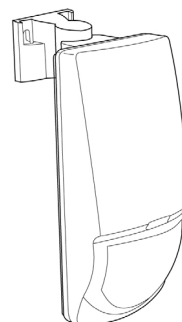

Fig.3

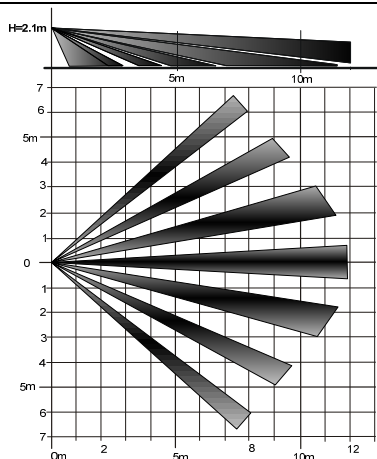

Fig.4

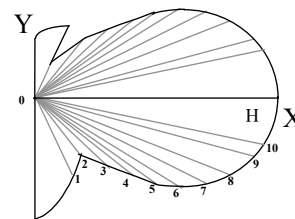

Table 1:

##	0	1	2	3	4	5	6	7	8	9	10
a	180	130	100	84	75	70	60	52	40	30	20
X	0	3	6	9	12	15	18	21	24	27	285
Y	105	6.09	7.15	8.98	8.01	105	1039	1024	8.73	7.23	5.03

X,Y are corresponds (m) of pattern points when H=30m

Fig.5

SWAN 1000

PASSIVE INFRARED & MICROWAVE DETECTOR With PET IMMUNITY

SETTING UP THE DETECTOR

LED INDICATION OF ALARM SIGNAL

Switch 1 of dipswitch DIP-5 use for setting - LED Enable / Disable
 Position Up – ON - LED ENABLE
 The RED LED will activate when the detector is in alarm condition.
 Position Down – OFF - LED DISABLE
 The LEDS are disabled.

Note: the state of the switch “LED” does not affect the operation of the relay.
 When an intrusion is detected, the LED will activate and the alarm relay will switch into alarm condition for 2 sec.

LED INDICATORS:
 YELLOW LED - MW detection's
 GREEN LED - PIR detection's
 RED LED - Alarm

PIR SENSITIVITY ADJUSTMENT

Switch 2 of dipswitch DIP5 use for setting the PULSE count function in order to provide PIR sensitivity control according to the environment.
 Position Down – OFF – High sensitivity
 For stable environments.
 Position Up – ON – Low sensitivity
 For harsh environments.

MW SENSITIVITY ADJUSTMENT

Switch 3 of dipswitch DIP5 use for setting the MW function in order to provide MW sensitivity control according to the environment.
 Position Down – OFF – High sensitivity
 For normal operation – immediate detection.
 Position Up – ON – Low sensitivity
 For harsh environments.

PET IMMUNITY SETTING

Switch 4 of dipswitch DIP5 use for setting the PET Immune function - Up to 15Kg or 25Kg, depending on the pet weight.
 Position Up - ON
 Immunity to an animal up to 15 kg
 Position Down - OFF
 Immunity to an animal up to 25 kg

ALARM MODE SETTING

Switch 5 of dipswitch DIP5 use for setting the mode of the detector.
 Position Down-“AND” - The alarm signal occurred only when both sensor signals (PIR & MW) are present at the same time.
 Position Up-“OR”- The alarm signal (relay activation) occurred when one of the sensor signals (PIR & MW) is present.

YOU MUST RESET THE DETECTOR BY DISCONNECT POWER SUPPLY AND RECONNECT IT AFTER FEW SECONDS.

RANGE ADJUSTMENT

“MW” POTENTIOMETER– adjustments according to protected area range- see fig.5.
 The potentiometer at mid-scale is equivalent to a distance of 15m, at min-scale – 7m.
 Rotate the potentiometer clockwise to increase range, counter-clockwise to decrease range.

Dimension change according to installation location and room size.

“PIR” POTENTIOMETER– adjustment according to protected area range.
 Use the Potentiometer marked “PIR” to adjust the detection sensitivity between 15% and 100%, according to walk test in the protected area. (Factory setting is 57%)
 Rotate the potentiometer clockwise to increase range, counter-clockwise to decrease range.

After adjusting the sensitivity perform a walk test to verify optimum correct sensitivity in the protected area.

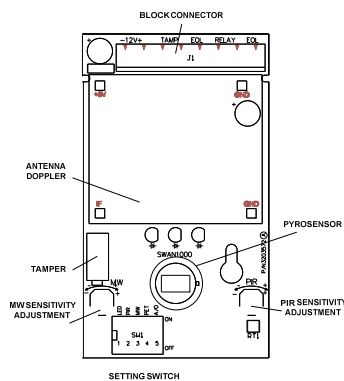

Fig. 6

Ceiling bracket base Wall bracket base

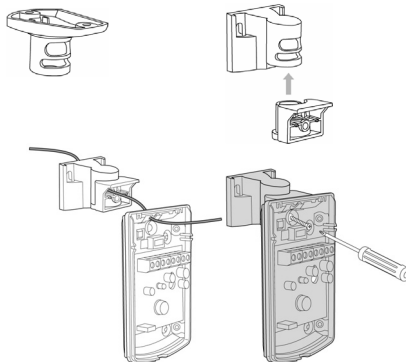

Fig.7

TECHNICAL SPECIFICATION

Detection Method	Quad element PIR & microwave pulse Doppler
Power Input	9.6 to 16 Vdc
Current Draw	Active : 23 mA Standby: 19 mA
Temperature Compensation	YES
Alarm Period	2 +/- 1 sec
Alarm Output	N.C 28Vdc 0.1 A with 10 Ohm series protection resistors
Tamper Switch	N.C 28Vdc 0.1A with 10 Ohm series protection resistor - open when cover is removed
Warm Up Period	1 min
LED Indicator	Green & Yellow LEDs are blinking during warm up period and self testing Red LED: ON during alarm Green LED: PIR CHANNEL Yellow LED: MW CHANNEL
Dimensions	123mm x 62mm x 38mm
Weight	120gr

STANDARDS COMPLIANCE

- EN 50130-4
- EN 61000-6-3
- EN 301489-3
- EN 301489-1
- EN 60950-1
- IEC 60950-1
- EN 50131-1
- EN 50131-2-4
- EN 50130-5
- EN 50131-6
- RoHS 2002/95/EC
- Security Grade 2, Environmental Class II

For more detailed instruction please refer the manuals which you could download from the internet at:
www.thecrowgroup.com



CROW ELECTRONIC ENGINEERING LTD. (“Crow”) - WARRANTY POLICY CERTIFICATE

This Warranty Certificate is given in favor of the purchaser (hereunder the “Purchaser”) purchasing the products directly from Crow or from its authorized distributor.
 Crow warrants these products to be free from defects in materials and workmanship under normal use and service for a period of 24 months from the last day of the week and year whose numbers are printed on the printed circuit board inside these products (hereunder the “Warranty Period”).
 Subject to the provisions of this Warranty Certificate, during the Warranty Period, Crow undertakes, at its sole discretion and subject to Crow's procedures, as such procedures are from time to time, to repair or replace, free of charge for materials and/or labor, products proved to be defective in materials or workmanship under normal use and service. Repaired products shall be warranted for the remainder of the original Warranty Period.
 All transportation costs and in-transit risk of loss or damage related, directly or indirectly, to products returned to Crow for repair or replacement shall be borne solely by the Purchaser.
 Crow's warranty under this Warranty Certificate does not cover products that is defective (or shall become defective) due to: (a) alteration of the products (or any part thereof) by anyone other than Crow; (b) accident, abuse, negligence, or improper maintenance; (c) failure caused by a product which Crow did not provide; (d) failure caused by software or hardware which Crow did not provide; (e) use or storage other than in accordance with Crow's specified operating and storage instructions.
 There are no warranties, expressed or implied, of merchantability or fitness of the products for a particular purpose or otherwise, which extend beyond the description on the face hereof.
 This limited Warranty Certificate is the Purchaser's sole and exclusive remedy against Crow and Crow's sole and exclusive liability toward the Purchaser in connection with the products, including without limitation - for defects or malfunctions of the products. This Warranty Certificate replaces all other warranties and liabilities, whether oral, written, (non-mandatory) statutory, contractual, in tort or otherwise.
 In no case shall Crow be liable to anyone for any consequential or incidental damages (inclusive of loss of profit, and whether occasioned by negligence of the Crow or any third party on its behalf) for breach of this or any other warranty, expressed or implied, or upon any other basis of liability whatsoever. Crow does not represent that these products can not be compromised or circumvented; that these products will prevent any person injury or property loss or damage by burglary, robbery, fire or otherwise; or that these products will in all cases provide adequate warning or protection.
 Purchaser understands that a properly installed and maintained product may in some cases reduce the risk of burglary, fire, robbery or other events occurring without providing an alarm, but it is not insurance or a guarantee that such will not occur or that there will be no personal injury or property loss or damage as a result.
 Consequently, Crow shall have no liability for any personal injury; property damage or any other loss based on claim that these products failed to give any warning.
 If Crow is held liable, whether directly or indirectly, for any loss or damage with regards to these products, regardless of cause or origin, Crow's maximum liability shall not in any case exceed the purchase price of these products, which shall be the complete and exclusive remedy against Crow.

P/N 7101572 REV. I A.Y. – R.C.

CROW ELECTRONIC ENGINEERING LTD.

12 Kineret St.
 Airport City, 70100 Israel
 Tel. +972 3 9726000
 Fax. +972 3 9726001
 sales@crow.co.il
 support@crow.co.il
www.thecrowgroup.com
CROW LATIN AMERICA USA INC.
 7200 NW 19 st.
 Suite 307
 Miami FI 33126, USA
 Tel. +305 513 4001
 Fax. +305 513 4005
 rejane@crowlatinamerica.com
www.crowlatinamerica.com
ARROWHEAD ALARM PRODUCTS
 344B, Rosedale Road
 Park Farm Industrial Estate
 Albany, Auckland
 New Zealand
 Tel. +64 9 414 0085
 Fax. +64 9 414 0088
www.aap.co.nz

These instructions supersede all previous issues in circulation prior to March 2012.